



Your Advantages

- Quick correction of insulation faults in complex power networks
- Universal auxiliary voltage range

Features

- Insulation troubleshooting in AC, DC and AC/DC networks (IT systems) in connection with the insulation fault locator RR 5887 according to DIN EN 61557-9 (VDE 0413-9):2009 and DIN EN 61557-1 (VDE 0413-1)
- Insulation coordination according to IEC 60664-1
- External control via insulation monitor possible
- Positive and negative test current to monitor DC networks and networks with simultaneous alternating current and direct current portions present
- RS-485 bus connection to synchronise the test current analysis and optionally for the connection to the Modbus RTU field bus
- Modbus RTU interface for controlling the insulation fault location and readout of insulation fault currents
- Pushbutton for manual test current output
- Terminal connection for automatic test current output
- Status output of insulation fault detection via external switching output
- Width: 105 mm

Product description

The locating current injector RR 5886 in connection with the insulation fault locator RR 5887 monitors and localises insulation faults in complex AC/DC networks (IT systems). The external current transformers work independently of each other. They are simply connected to the measuring channels of the insulation fault locator RR 5887 and are calibrated by it. The number of measuring channels is increased by combining several insulation fault locators via a RS-485 bus connection. The search for insulation faults in extensive networks can be refined in this manner. Two different alarm levels facilitate the timely detection of a dangerous insulation state. The devices are operated easily and intuitively thanks to automatic balancing and a clear layout of the setting elements. The early detection and localisation of insulations faults permits their quick and targeted correction. As user you will benefit from the operating reliability and high availability of your system.

Approvals and Markings



Application

- Insulation fault detection in complex AC/DC networks
- Industry, shipbuilding, plant engineering, PV systems
- Quick fault correction of insulation faults in medical facilities

Function Diagram

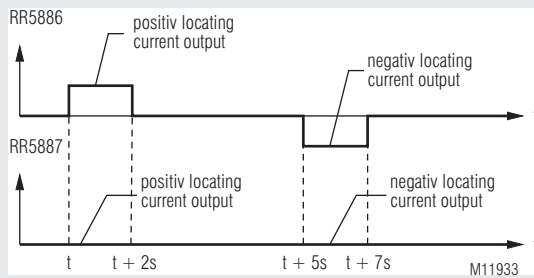

Circuit Diagram

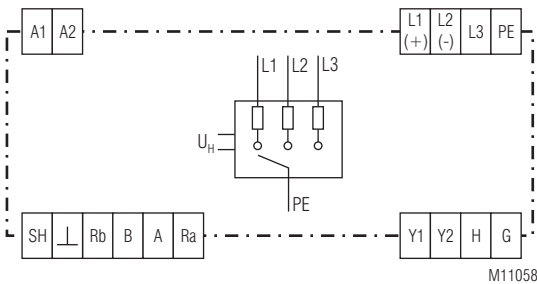

Indication

- Green LED "ON": On, when supply connected
- Yellow LED „BUS“: Indicates RS-485 bus activity
- Yellow LED „“: Indicates the output of the positive test current pulse
- Yellow LED „“: Indicates the output of the negative test current pulse

Connection Terminals

Terminal designation	Signal description
A1(+), A2	Auxiliary voltage AC or DC
L1(+), L2(-), L3, PE	IT network voltage connections AC / DC / 3AC
SH, GND, Rb, B, A, Ra	RS-485 Bus (galvanic separation)
Y1, Y2	Switching input Test current output to control
G, H	Status switching output Test current output

Notes

Switching input

The test current release can be externally controlled via the switching input (terminals Y1, Y2). Bridging the terminals Y1-Y2 overrules the start-stop button and hence deactivates it. If the terminal connection is left open, the test current release can be controlled manually via the start/stop button. The test current release is activated and deactivated in alternating fashion with each push of the button.

While the terminals Y1-Y2 and the start-stop button, respectively, allow the release of the test current, the point of time when it is actually output is determined by the bus mode (s. below RS-485 bus connection).

Attention:

A started current output cycle (12 seconds) will last to the end and cannot be interrupted.

If the test current output is controlled via the terminals Y1,Y2, a complete test cycle is performed after the release has been cancelled in order to enable the insulation fault locators to confirm a fixed insulation fault.

The switching input can also be selected directly via an external device, e.g. insulation monitoring device. The switching input is supplied as well via the electrically separated supply voltage. The switching input can therefore be switched via a transistor or a relay output.

Configuration options for the test current release:

- Y1 Automatic test current release
 Y2
- Y1 Release of the test current output through
 Y2 higher level control or external switch
- Y1 Test current release controlled manually
 Y2 via device pushbutton

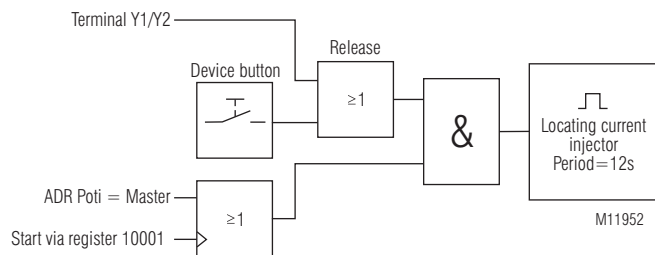

Switching output

The device is equipped with a transistor switching output (terminals G, H), which is protected by a series-connected PTC (RN = 220 Ω). In the idle state (no test current output), the output is high-resistance. During test current output, the output is low-resistance (RN) and delivers a low-level in conjunction with a series resistor and an external voltage source.

RS-485 bus connection

Depending on the application the RS-485 bus mode is either master mode or slave mode. This is set on a 10 step rotary switch.

If the insulation fault location system is part of a Modbus RTU field bus system, the pulse generator works as a bus slave. With the rotary switch a free channel in the range of 101 to 109 has to be selected.

If the insulation fault locating system is working independently, the test current generator works in master mode and the channel selector has to set to the relevant position.

The rotary switches for baudrate selection of all RR 5886 and RR 5887 devices have to be identical independent of the bus operation mode. The preferred baudrate is 9600 Baud (rotary switch position 4).

The RS-485 telegrams the locating current injector sends to synchronise the insulation fault measurement are identical in both bus modes.

Attention:

While in the master mode the output of the telegrams occurs automatically every 12 seconds, in slave mode it occurs as response to a modbus master request. A pending test current output is announced here in the user data range of the response telegram.

The insulation fault locators RR 5887, generally working in slave mode, synchronise themselves by monitoring the RS-485 telegram network with manual test current output.

Notes

Common operation of insulation monitor and insulation fault location system

Insulation monitoring and insulation fault location are often used in addition (s. connection example). As a rule, an insulation monitor detects an insulation fault and then controls an insulation fault location system that locates the fault. During localization, the insulation monitor should temporarily stop his monitoring activity in order to avoid mutual interference between the insulationmonitoring device and the localization system.

Modbus RTU

For communication between motor controller and a supervising control the Modbus RTU protocol according to Specification V 1.1b3 is used.

Address- / Baud rate setting

Pos. Potentiom. ADR	Master	1	2	3	4	5	6	7	8	9
Address Modbus RTU	---	101	102	103	104	105	106	107	108	109

Pos. Potentiom. BAUD	1	2	3	4	5	6	7	8
Baud rate Baud	1200	2400	4800	9600	19200	38400	57600	115200

Device address and baudrate are only read once after application of the auxiliary voltage.

Bus Interface

Protocol	Modbus Seriell RTU
Address	101 bis 109
Baud rate	1200, 2400, 4800, 9600, 19200, 38400, 57600, 115200 Baud
Data bit	8
Stop bit	2
Parity	None

More information about the interface, wiring rules, device identification and communication monitoring can be found in the Modbus user manual.

Function-Codes

At RR 5886 the following function codes are implemented:

Function-Code	Name	Description
0x02	Read Discrete Inputs	Device state read / Start test current output
0x04	Read Input Register	Device state / Device ID data read

Technical Data

Auxiliary voltage

Measured nominal voltage U_B:	AC/DC 24 ... 80 V; AC/DC 85 ... 230 V
Operating voltage U_o:	AC/DC 21 ... 88 V; AC 77 ... 265 V, DC 77 ... 290 V
Frequency range:	DC or AC 45 ... 400 Hz
Nominal consumption:	DC max. 3 W AC max. 3.5 VA

Monitored network

Operating voltage U_B:	DC / AC / 3AC 21 ... 500 V
Measured nominal voltage U_o:	DC / AC / 3AC 24 ... 455 V
Frequency range:	AC/3AC 40 ... 60 Hz
Rated current range for insulation test currents:	1 ... 5 mA
Maximum test current output:	6.5 mA
Measuring accuracy:	± 10%
Test clock/test pause:	2 s / 3 s
Bus (galvanic separation):	RS-485

Switching input

Terminals:	Y1, Y2
Connection (passive)	
Low-signal:	Bridge set / input low resistance
High-signal:	Input open / input high resistance
Connection (active)	
Voltage range (low/high):	0V / 12 ... 24 V
Max. switching current (24 V):	10 mA

Switching output

Terminals:	H(+), G(-)
Switching output (passive):	Transistor outputs
Test current output:	Output low resistance (minimal 220 Ω via PTC)
No test current output:	Output high resistance
Switching voltage max.:	24 V
Switching current max. (24 V):	10 mA

RS-485 Bus

Terminals:	SH, L, Rb, B, A, Ra
Bus:	Galvanic separation
Geräte Mode	
Bus-Master/Slave:	Adjustable via rotational switch
Transmission medium:	Twisted, shielded two-wire line (SH)
Data transmission rate:	115.2 kBit/s
Network termination:	Bus termination via bridges Rb, B and Ra, A

General Data

Nominal operating mode:	Continuous operation
Temperature range:	
Operation:	- 20 ... + 60 °C
Storage:	- 25 ... + 60 °C
Relative air humidity:	93% at 40 °C
Altitude:	< 2000 m
Clearance and creepage distance	
Rated impulse voltage/ pollution degree:	6 kV / 2 IEC 60664-1
EMC	
Electro static discharge (ESD):	8 kV (air) IEC/EN 61000-4-2
HF irradiation	
80 MHz ... 2.7 GHz:	10 V / m IEC/EN 61000-4-3
Fast transients:	2 kV IEC/EN 61000-4-4
Surge voltage	
Between	
wires for power supply:	2 kV IEC/EN 61000-4-5
Between wire and ground:	4 kV IEC/EN 61000-4-5
HF-wire guided:	10 V IEC/EN 61000-4-6
Interference suppression:	Limit value class B EN 55011

Technical Data

Degree of protection

Housing:	IP 40	IEC/EN 60529
Terminals:	IP 20	IEC/EN 60529
Housing:	Thermoplastic with VO behaviour acc. to UL subject 94	

Vibration resistance:

Amplitude 0.35 mm frequency 10...55 Hz, IEC/EN 60068-2-6 20 / 060 / 04
--

Climate resistance:

Terminal designation:

EN 50005

Wire connection

DIN 46228-1/-2/-3/-4

Fixed screw terminals

Cross section:	0.2 ... 1.5 mm ² (AWG 24 - 16) solid or 0.2 ... 1.5 mm ² (AWG 24 - 16) stranded wire with ferrules
----------------	--

Stripping length:

7 mm

Fixing torque:

0.4 Nm

Mounting:

DIN-rail

IEC/EN 60715

Weight:

Approx. 200 g

Dimensions

Width x height x depth:	105 x 90 x 71 mm
--------------------------------	------------------

Standard Type

RR 5886 AC/DC 85 ... 230 V

Article number: 0068220

• Auxiliary voltage: AC/DC 85 ... 230 V

• Rated current range for insulation test currents: 1 ... 5 mA

• Response sensitivity: 0.5 mA

• Maximum test current output: 6.5 mA

• Width: 105 mm

Variant

RR 5886/010 AC/DC 85 ... 230 V

• Article number: 0067693

• Auxiliary voltage: AC/DC 85 ... 230 V

• Rated current range for insulation test currents: 0.3 ... 1.0 mA

• Response sensitivity: 0.3 mA

• Maximum test current output: 1.0 mA

• Width: 105 mm

Ordering Example for Variants

RR 5886 / 0 _ 0 AC/DC 85 ... 230 V

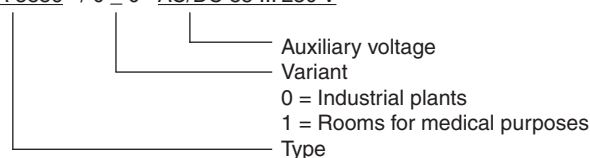

Parameter table

Every slave owns an output- configuration- and actual value table. In these tables it is defined under which address the parameters can be found.

Discrete Inputs:

Register-Address	Protocol-Adresse	Name	Value range	Description	Data type	Access rights
10001	0	New test cycle started	0 ... 1	0: No test current release or ongoing test cycle 1: New test cycle started	BIT	read

Input Register (Device state and measuring values):

Register-Address	Protocol-Adresse	Name	Value range	Description	Data type	Access rights
30001	0	State Test current output	0 ... 1	0x0000: No test current output 0x0001: Test current output active	UINT16	read

Sequence Diagram Modbus Control Insulation Fault Location

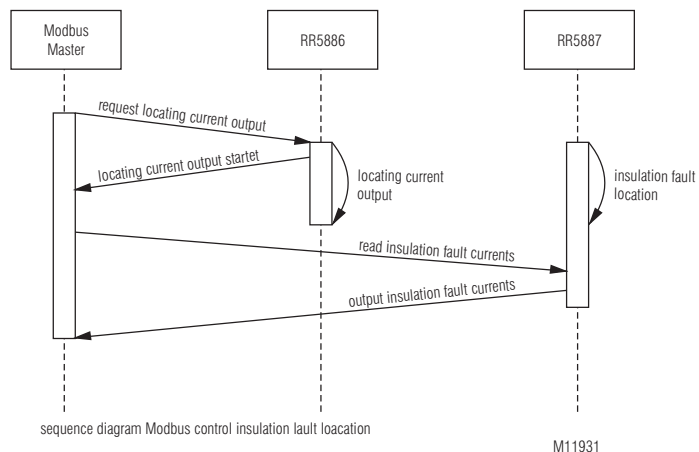

Modbus Control Insulation Fault Detection Telegram Examples

Request test current output:
6Xh, 02h, 00h, 00h, 00h, 01h, XXh, XXh

Read insulation fault currents (4-channel):
6Xh, 04h, 00h, 04h, 00h, 04h, XXh, XXh

Read insulation fault currents (8-channel):
6Xh, 04h, 00h, 04h, 00h, 08h, XXh, XXh

System overview

Insulation fault without external Modbus-Master (stand-alone system)

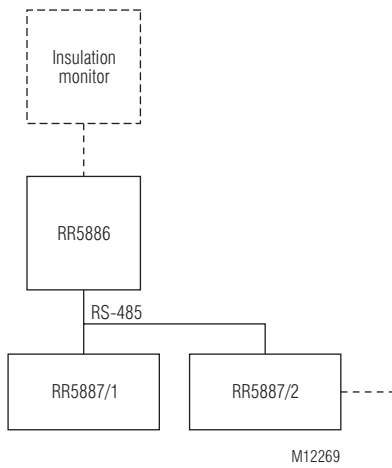

Connection to measuring bus /Profibus gateway

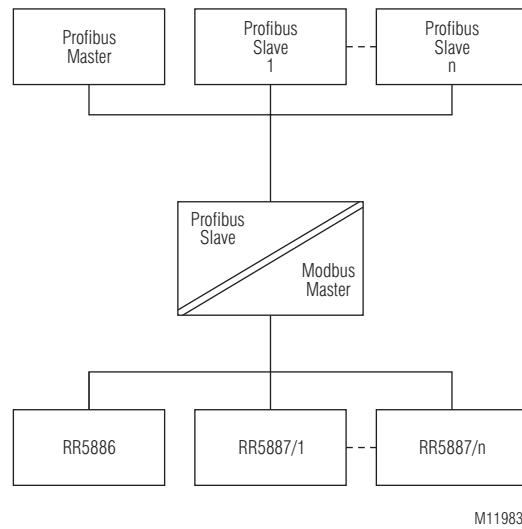

Example for Modbus setting:

Device	Adress-Potentiometer	Potentiometer position	Modbus Adress
RR 5886	ADR 101 – 109	Master	-
RR 5887/1	ADR 100 – 109	0 (optional)	-
RR 5887/2	ADR 100 – 109	0 (optional)	-
...	ADR 100 – 109	0 (optional)	-

Insulation fault with external Modbus-Master

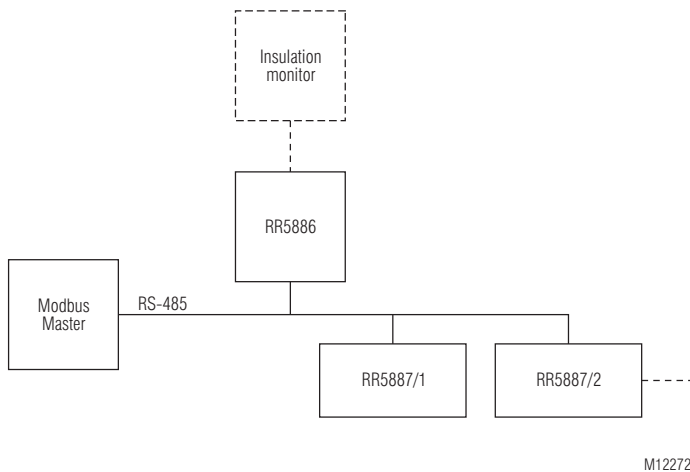

Example for Modbus setting:

Device	Adress-Potentiometer	Potentiometer position	Modbus Adress
RR 5886	ADR 101 – 109	1	101
RR 5887/1	ADR 100 – 109	0	100
RR 5887/2	ADR 100 – 109	2	102
...	ADR 100 – 109

- Insulation fault detection in AC / DC / 3AC IT networks in connection with the insulation fault locator RR 5887
- External selection via an insulation monitoring device possible

Connection Examples

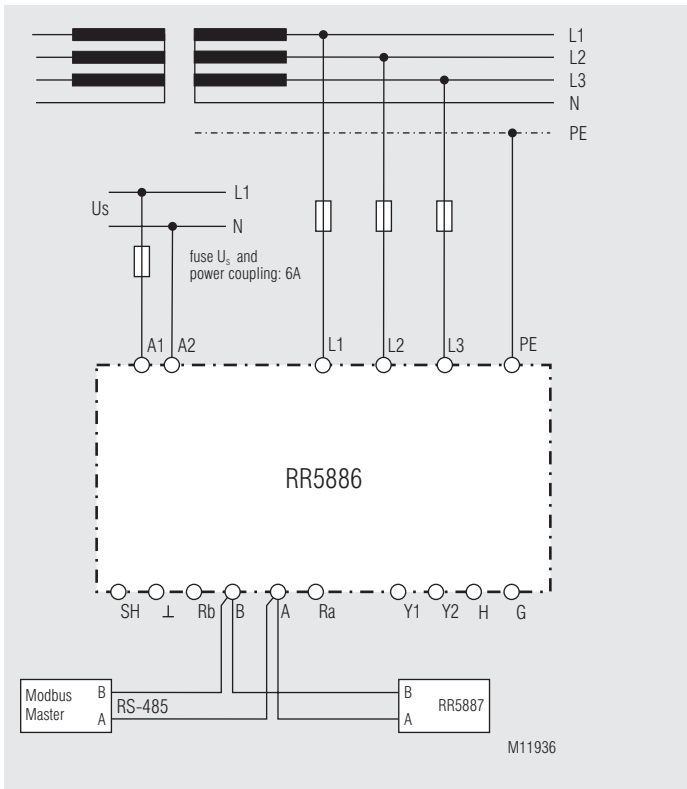

3AC network with manual test current output;
EDS measuring bus connection without bus termination

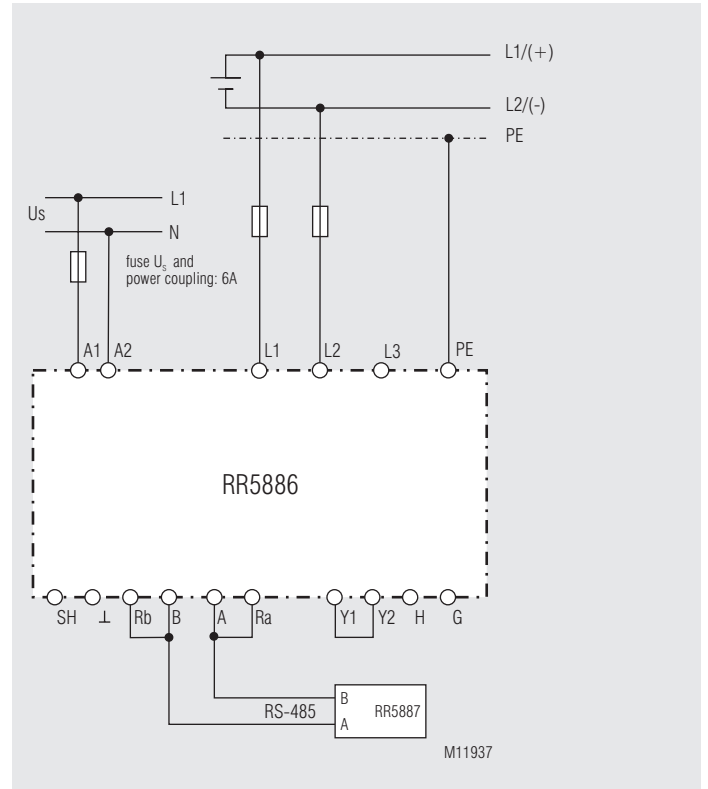

AC (DC) network with automatic test current output;
RR 5886 is bus master; bus termination on the device

Connection Example

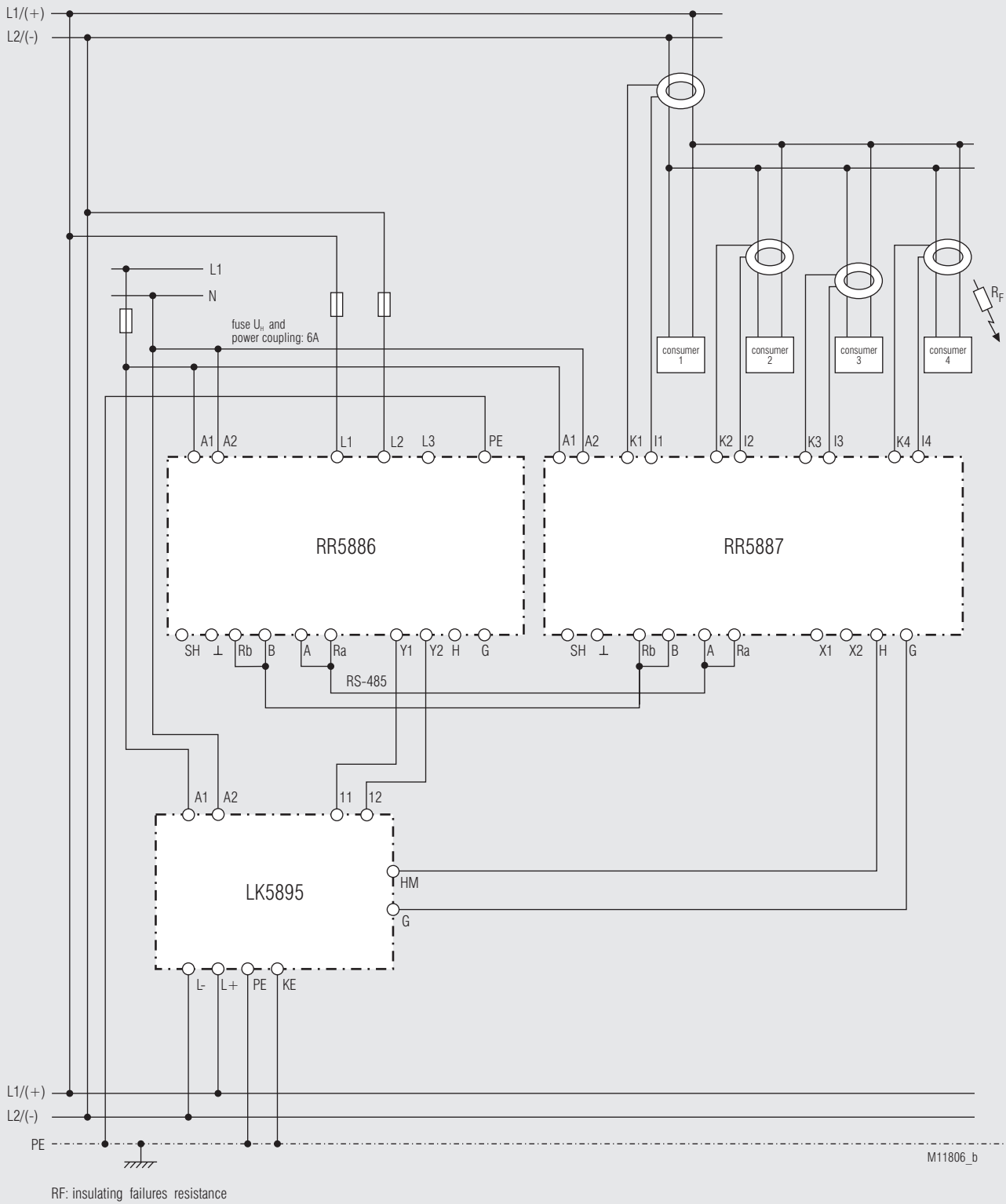

Insulation monitoring and insulation fault detection with 4 connected current transformers in a AC (DC)- network with subdistribution - insulation fault detection can be controlled by the insulation monitor /LK 5895; bus termination of the first and last device on the RS-485 bus.

Connection Example

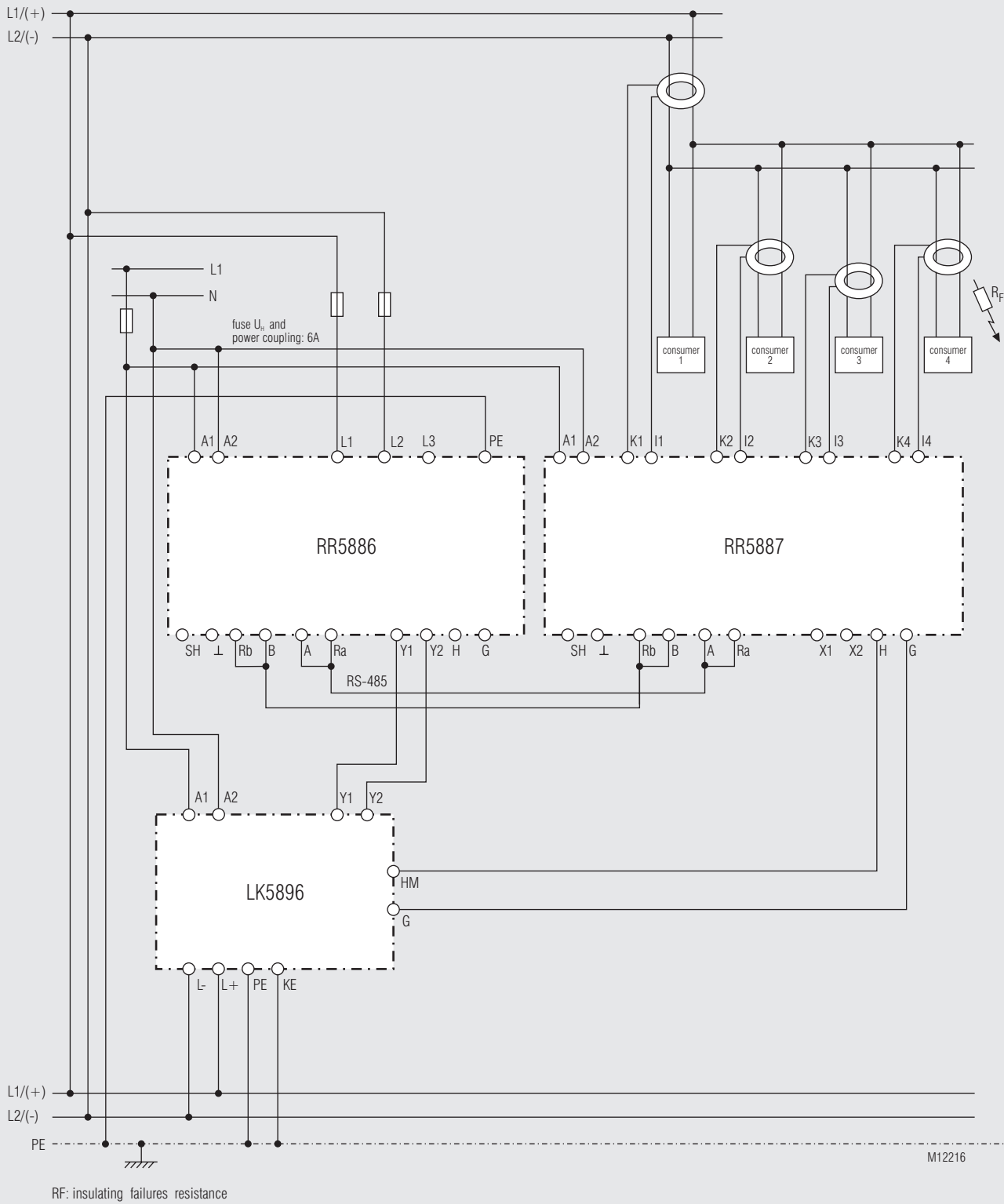

Insulation monitoring and insulation fault detection with 4 connected current transformers in a AC (DC)- network with subdistribution - insulation fault detection can be controlled by the insulation monitor /LK 5896; bus termination of the first and last device on the RS-485 bus.

Connection Example

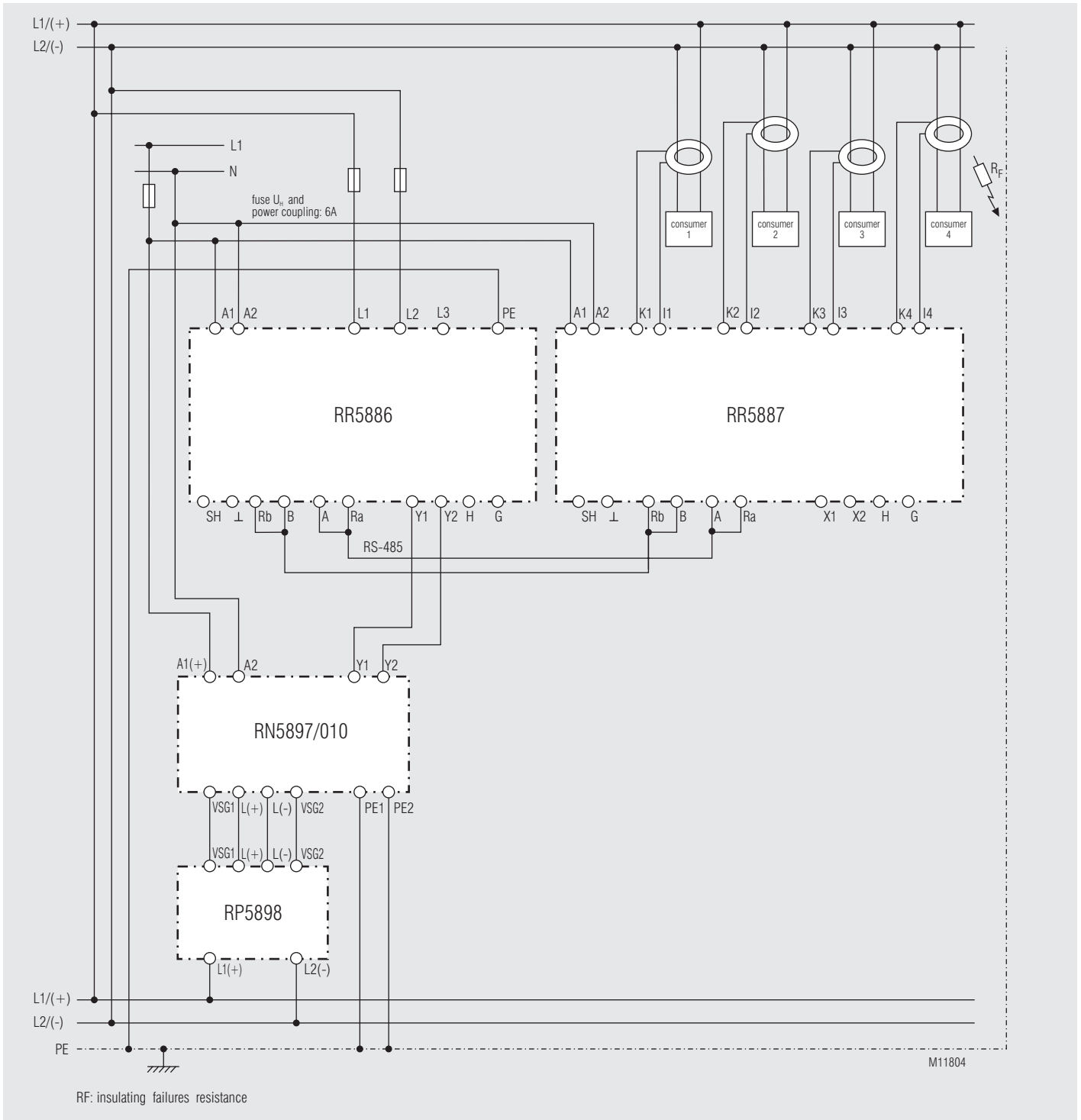

Insulation monitoring and insulation fault detection with 4 connected current transformers in a AC (DC)- network with subdistribution - insulation fault detection can be controlled by the insulation monitor (RN 5897/010); bus termination of the first and last device on the RS-485 bus.

Connection Example

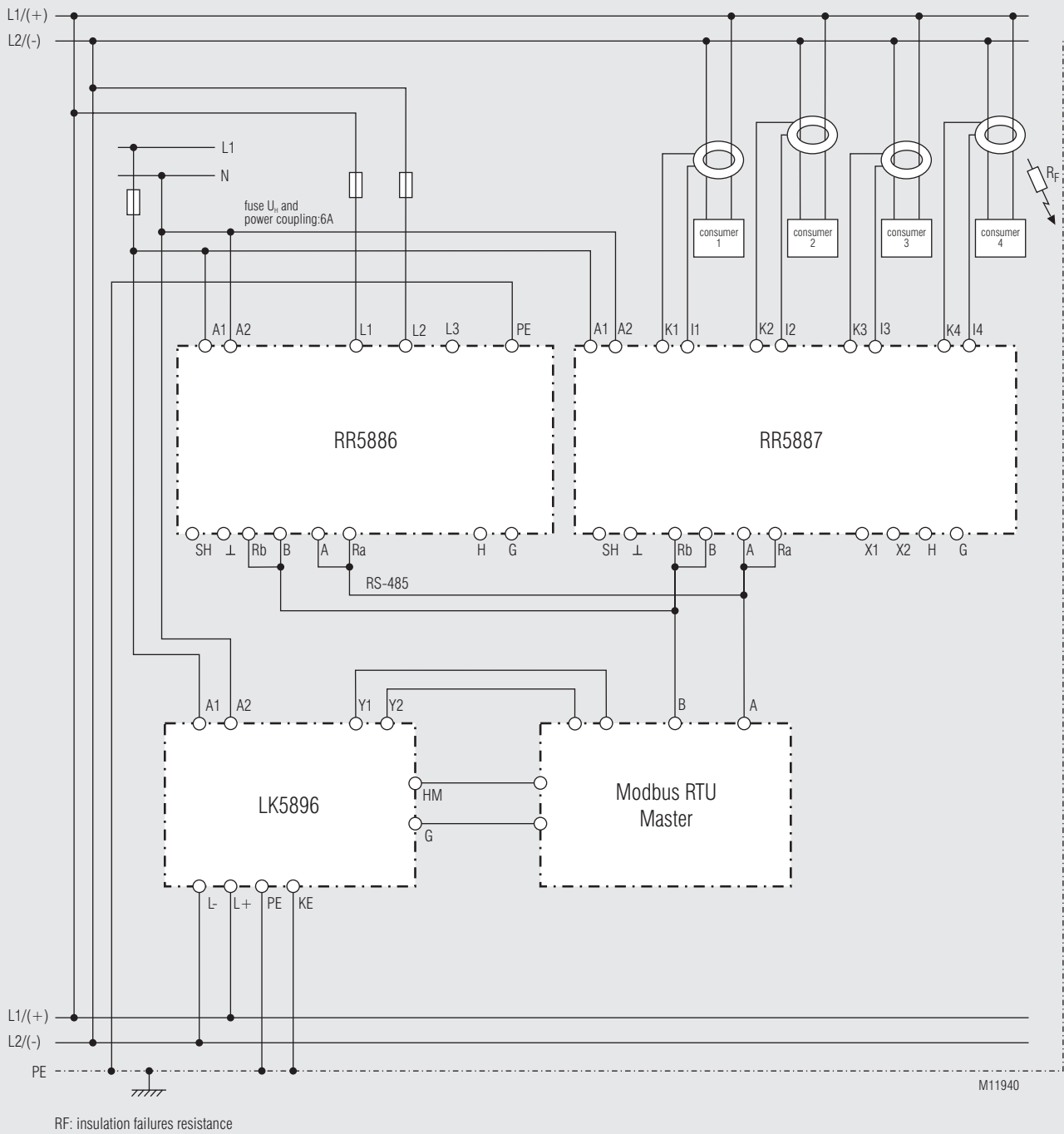

Insulation fault location via Modbus control with external master.

